

構成内容 / Components				
No.	名称 / Part name	数量 / Pcs	材質 / Material	色・表面処理 / Color・Finish
1	フレーム Frame	4	アルミ押出材 A6063S-T5 Extruded aluminium A6063S-T5	シルバーアルマイト, ブラックアルマイト Silver, Black・Anodized
2	コーナーブロック Corner block	4	ABS樹脂 UL94HB ABS UL94HB	ライトグレー, ブラック Light gray, Black
3	コーナーキャップ / Blind plug	8	エラストマ / TPE	ライトグレー, ブラック / Light gray, Black
4	ハメ込みパネル Slide panel	1	アルミ板 A1100P Aluminium A1100P	シルバーアルマイト, ブラック・塗装 Silver・Anodized, Black・Painted
5	ねじ止めパネル Screwed panel	1	アルミ板 A1100P Aluminium A1100P	シルバーアルマイト, ブラック・塗装 Silver・Anodized, Black・Painted
6	取付ビス (ナベ M3 x 15) Screw (Pan head M3 - 15)	16	鉄 Steel	三価クロメート Trivalent chromate
7	取付ビス (座付丸皿 M3 x 5) Screw (Slotted raised countersunk M3 - 5)	12	鉄 Steel	ニッケルメッキ, 三価黒クロメート Nickel plated, Black trivalent chromate

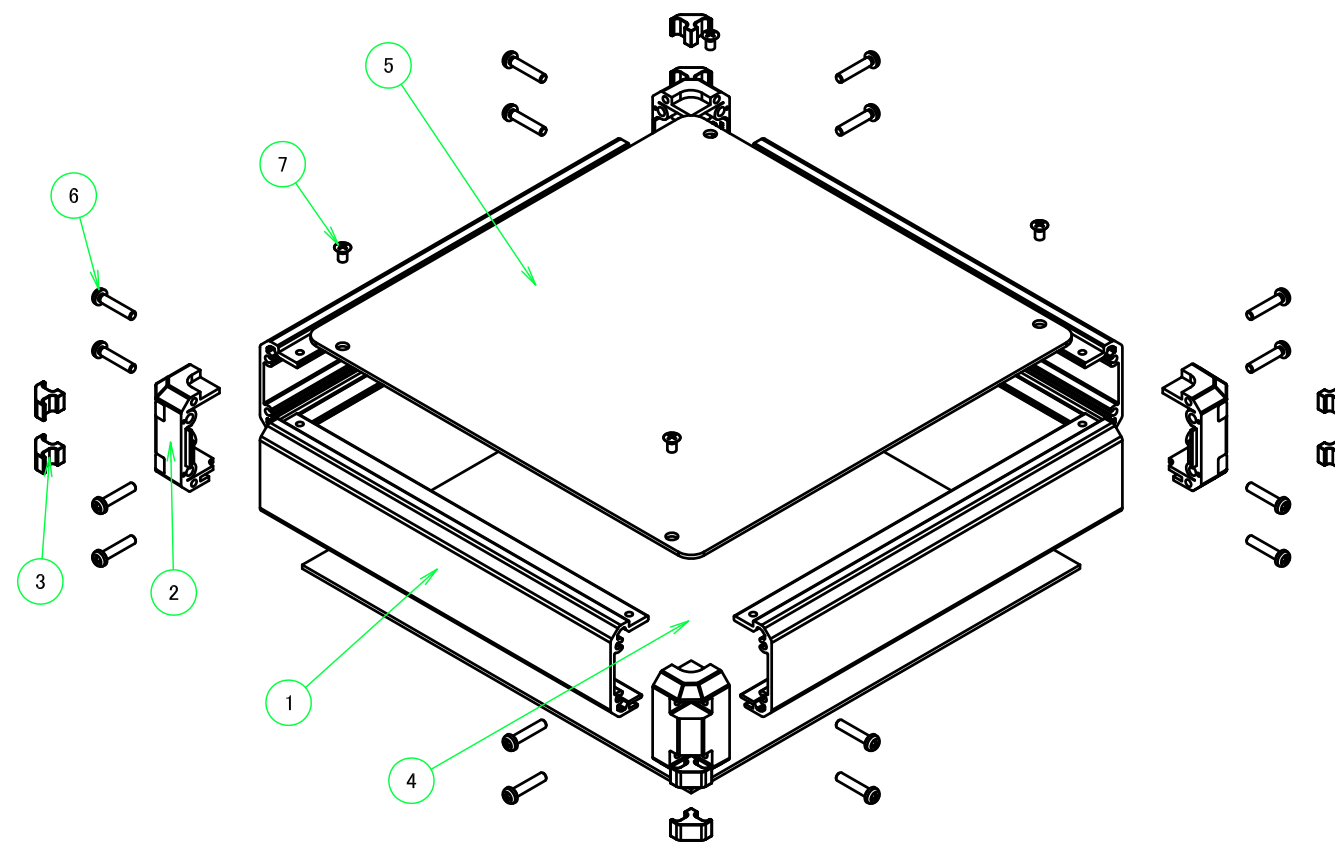

ケース型番 FCS
Product Number

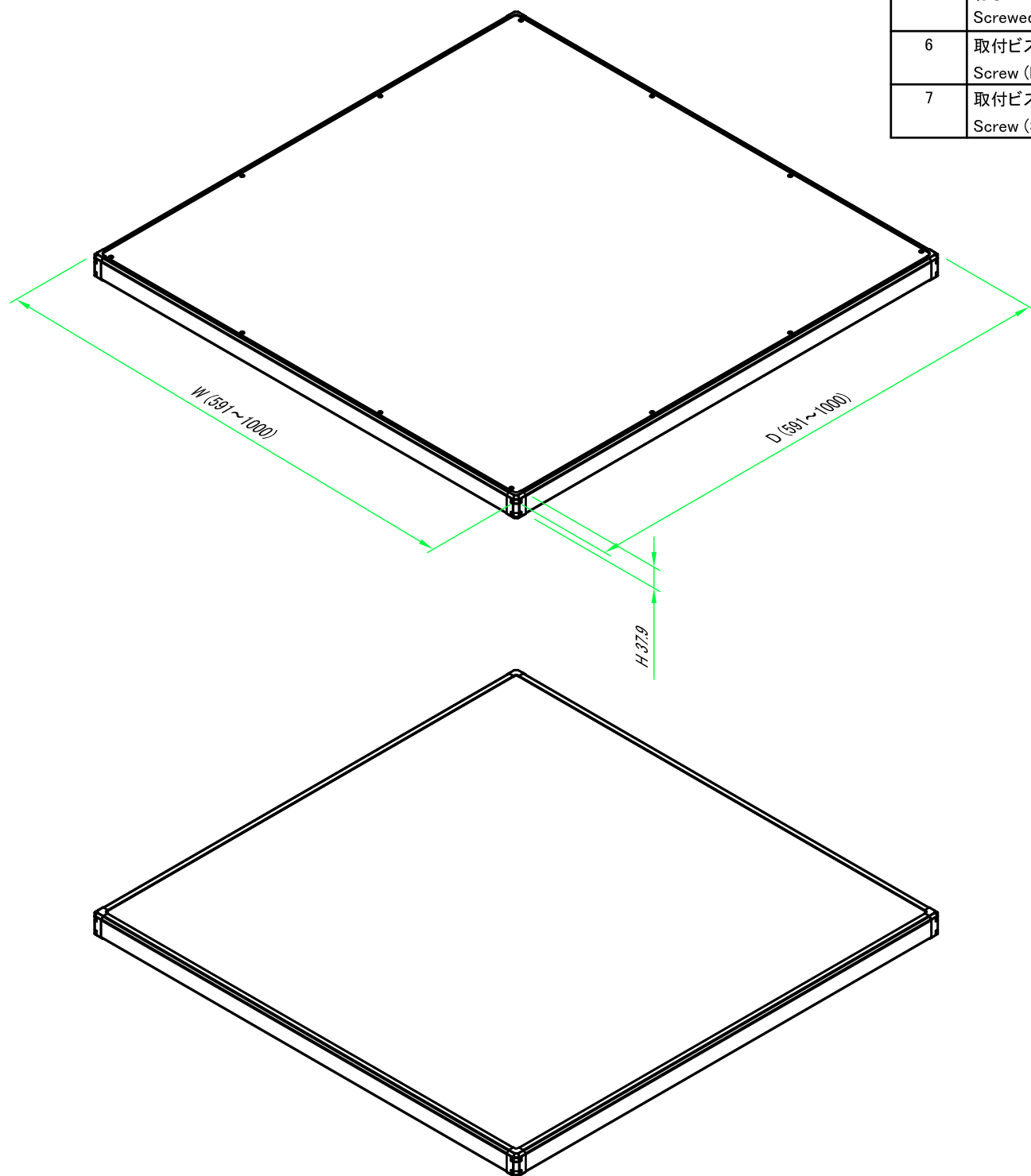
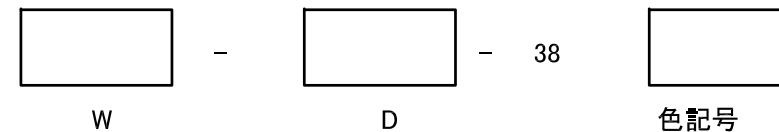

色記号
Color Code

W, D 寸法制限範囲 / Dimension limit range	
W	D
591 ~ 1000	591 ~ 1000

色仕様 (型番末尾口) / Color Type (End product number口)			
記号 / Code	パネル / Panel	フレーム / Frame	コーナー / Corner
GSS	シルバー / Silver	シルバー / Silver	ライトグレー / Light gray
BSS	シルバー / Silver	シルバー / Silver	ブラック / Black
BBS	シルバー / Silver	ブラック / Black	ブラック / Black
BBB	ブラック / Black	ブラック / Black	ブラック / Black

株式会社タカチ電機工業 TAKACHI ELECTRONICS ENCLOSURE CO., LTD.			品名/Title フリーサイズボックス CUSTOM DIMENSIONS BOX	尺度/Scale 1 / 7
承認/Approved 中根	検図/Checked 野村	製図/Created 常山	型番/Product number FCS□-□-38□ (W591~1000, D591~1000)	
			作成日/Date 2019/09/03	

フレーム1側 / Frame1 side



フレーム3側 / Frame3 side

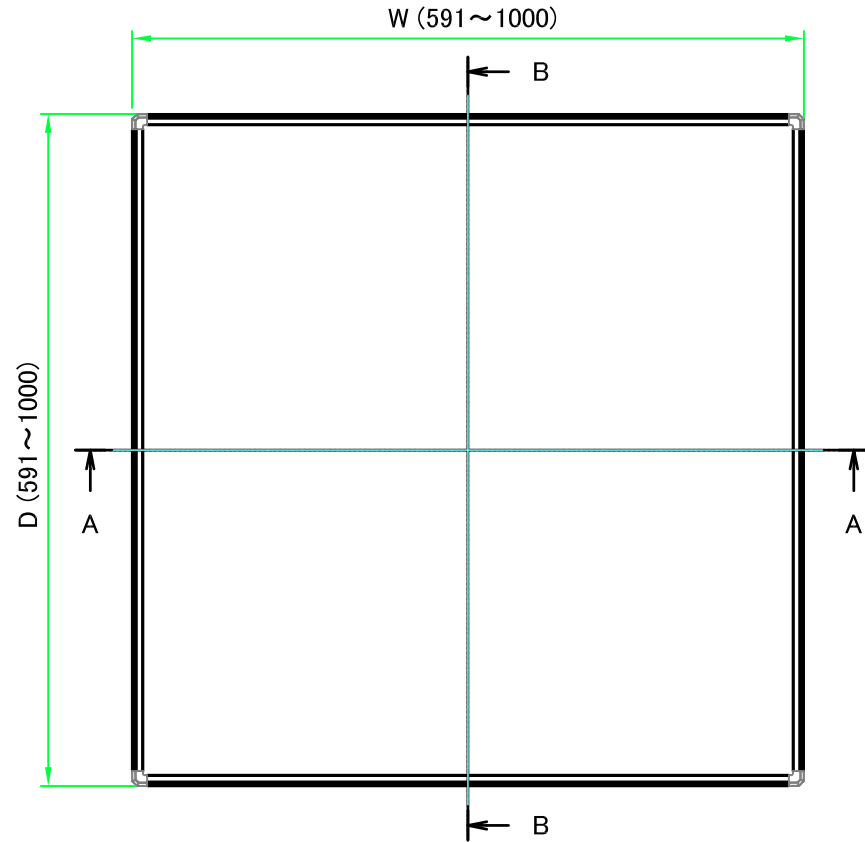

フレーム4側 / Frame4 side



B-B (1:9)

有効寸法 / Max dim. 31.5

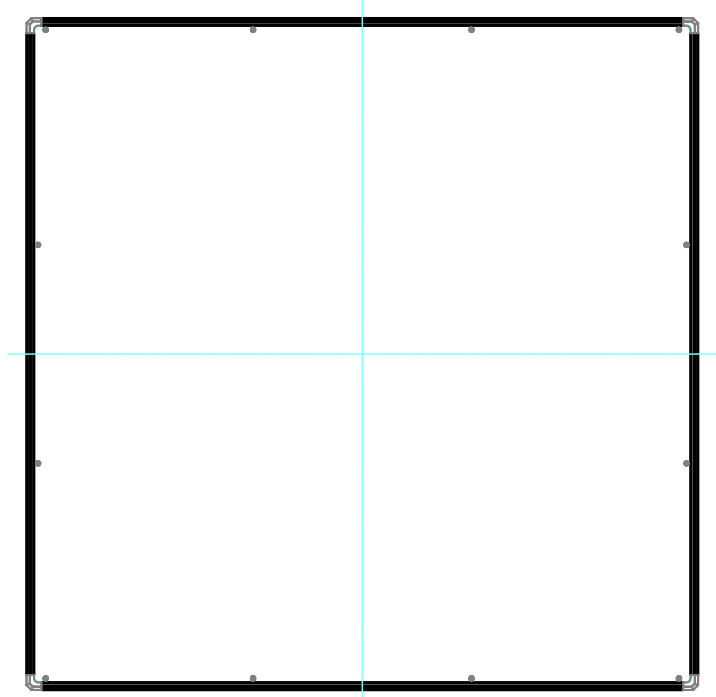
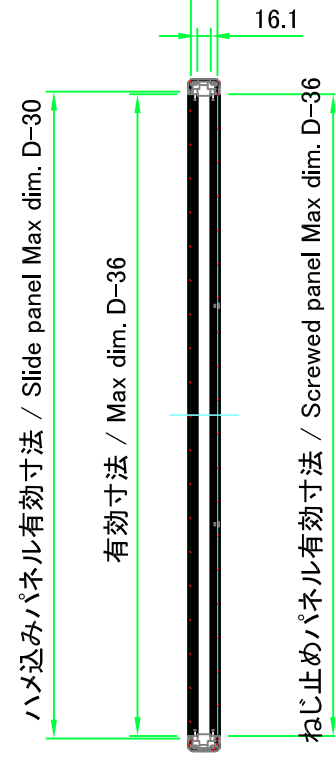

フレーム2側 / Frame2 side

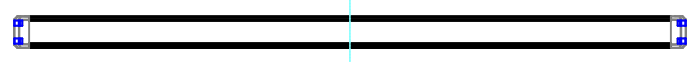

A-A (1:9)

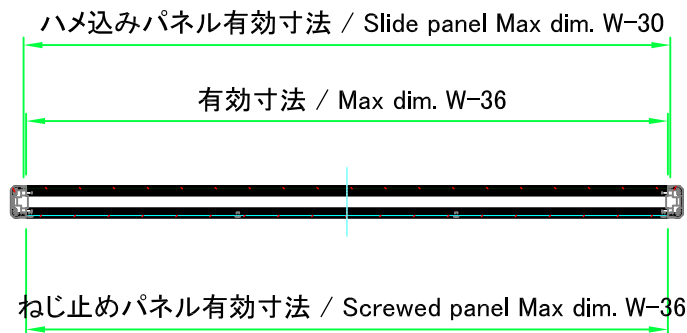

株式会社タカチ電機工業 TAKACHI ELECTRONICS ENCLOSURE CO., LTD.			品名/Title フリーサイズボックス CUSTOM DIMENSIONS BOX	尺度/Scale 1:9
承認/Approved	検図/Checked	製図/Created	型番/Product number FCS□-□-38□ (W591~1000, D591~1000)	
中根	野村	常山	作成日/Date 2019/09/03	2 / 7

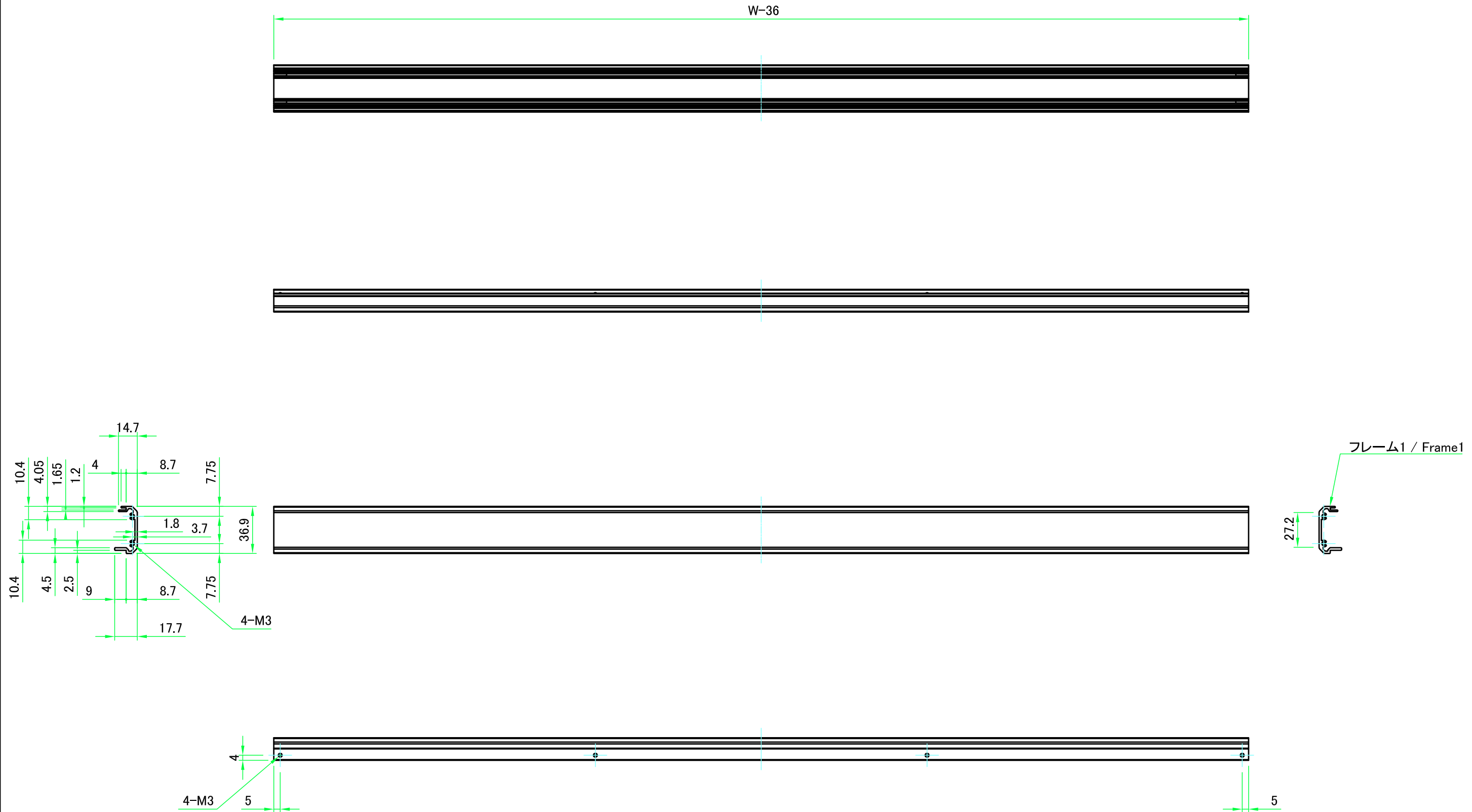

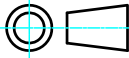

 株式会社タカチ電機工業 TAKACHI ELECTRONICS ENCLOSURE CO., LTD.			品名/Title フレーム1 Frame1	 尺度/Scale 1:3
承認/Approved	検図/Checked	製図/Created	型番/Product number H37.9 - W591~1000	
中根	野村	常山	作成日/Date 2019/09/03	3 / 7



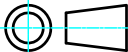

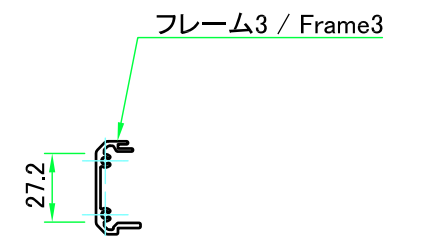
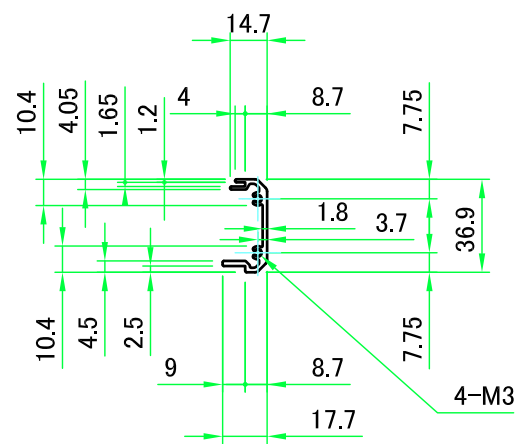
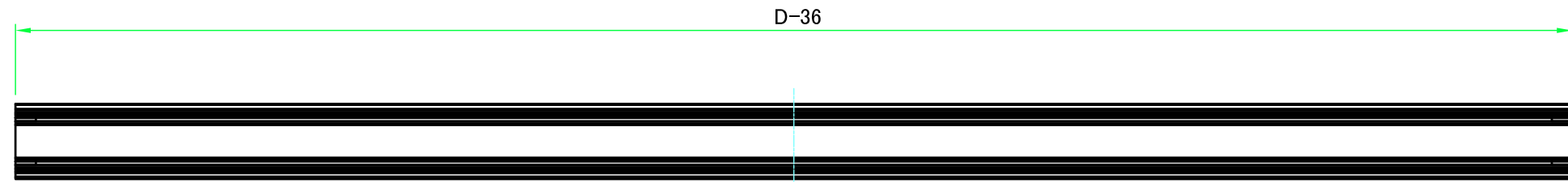
フレーム2 / Frame2

 株式会社タカチ電機工業 TAKACHI ELECTRONICS ENCLOSURE CO., LTD.			品名/Title フレーム2 Frame2	
承認/Approved 中根	検図/Checked 野村	製図/Created 常山	型番/Product number H37.9 - W591~1000	
			作成日/Date 2019/09/03	4 / 7

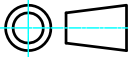

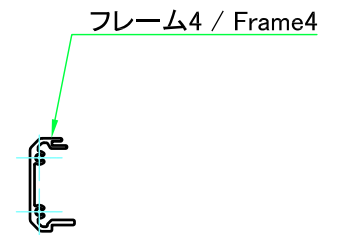
 株式会社タカチ電機工業 TAKACHI ELECTRONICS ENCLOSURE CO., LTD.			品名/Title フレーム3 Frame3	 尺度/Scale 1:3
承認/Approved	検図/Checked	製図/Created	型番/Product number H37.9 - D591~1000	
中根	野村	常山	作成日/Date 2019/09/03	5 / 7

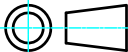

 株式会社タカチ電機工業 TAKACHI ELECTRONICS ENCLOSURE CO., LTD.			品名/Title フレーム4 Frame4	
承認/Approved 中根	検図/Checked 野村	製図/Created 常山	型番/Product number H37.9 - D591~1000	尺度/Scale 1:3
			作成日/Date 2019/09/03	6 / 7

ハメ込みパネル / Slide panel

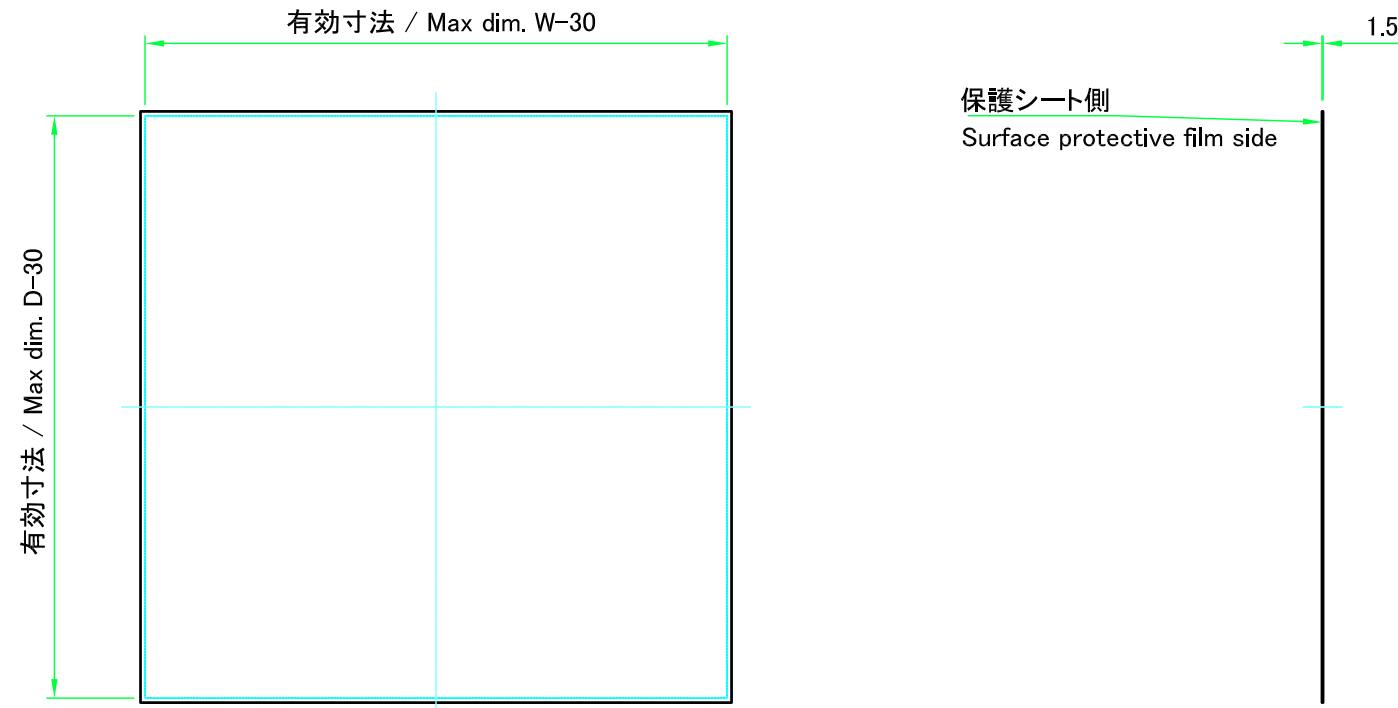

パネル表面 / Panel Frontside

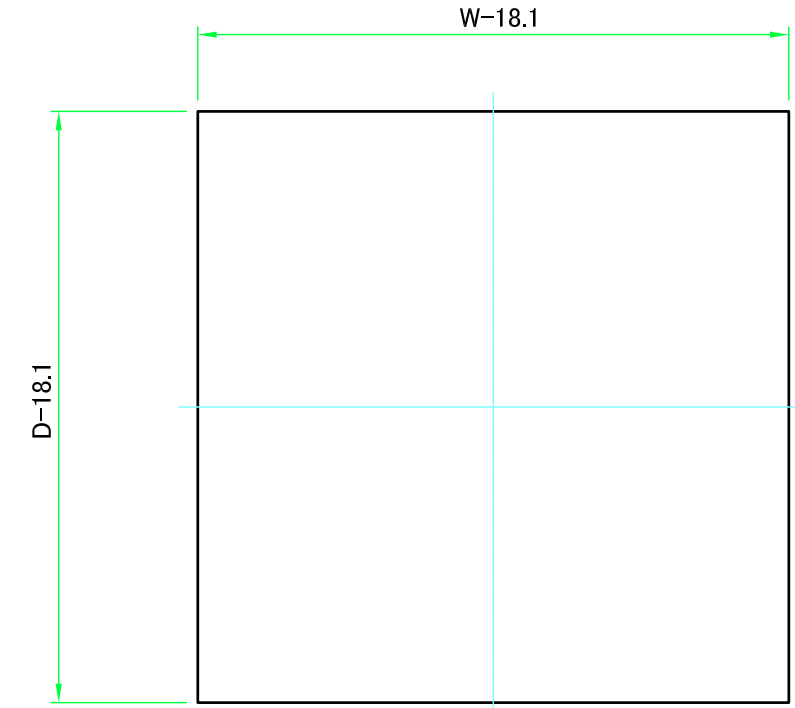

パネル裏面 / Panel Backside

ねじ止めパネル / Screwed panel

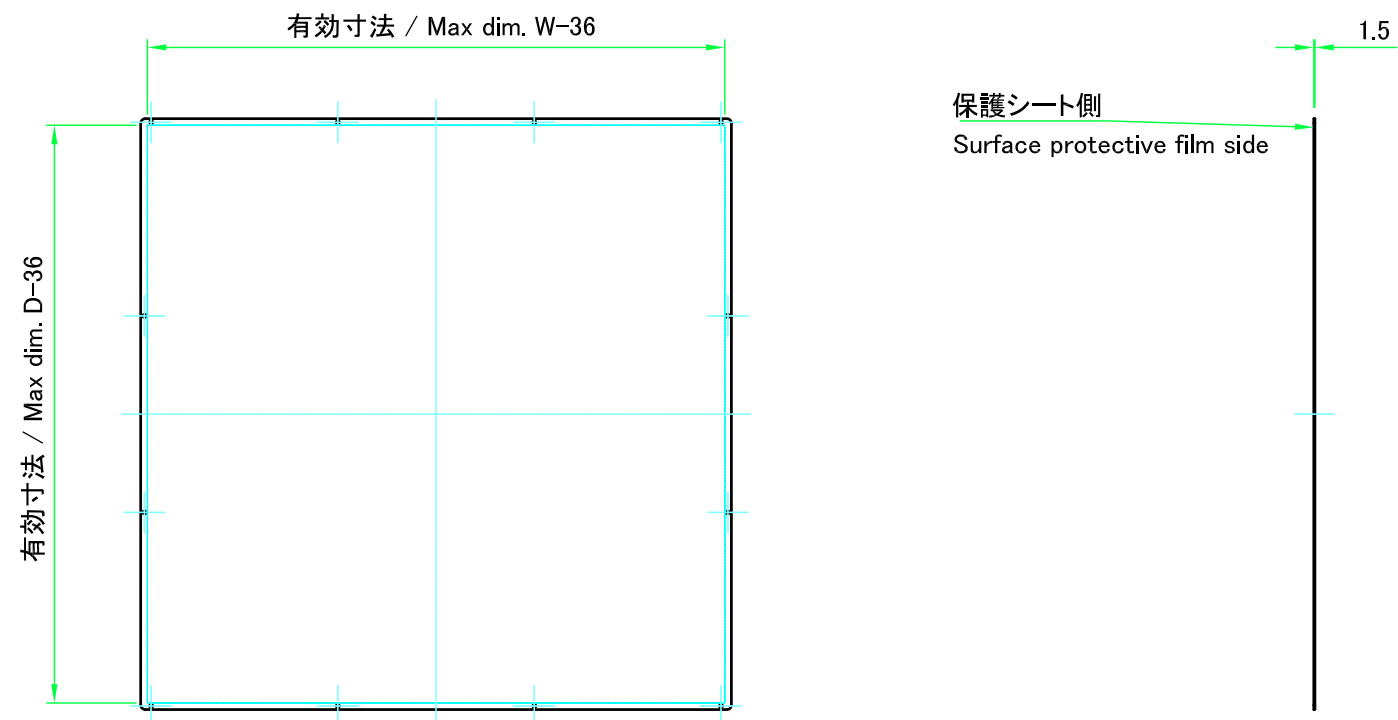

パネル表面 / Panel Frontside

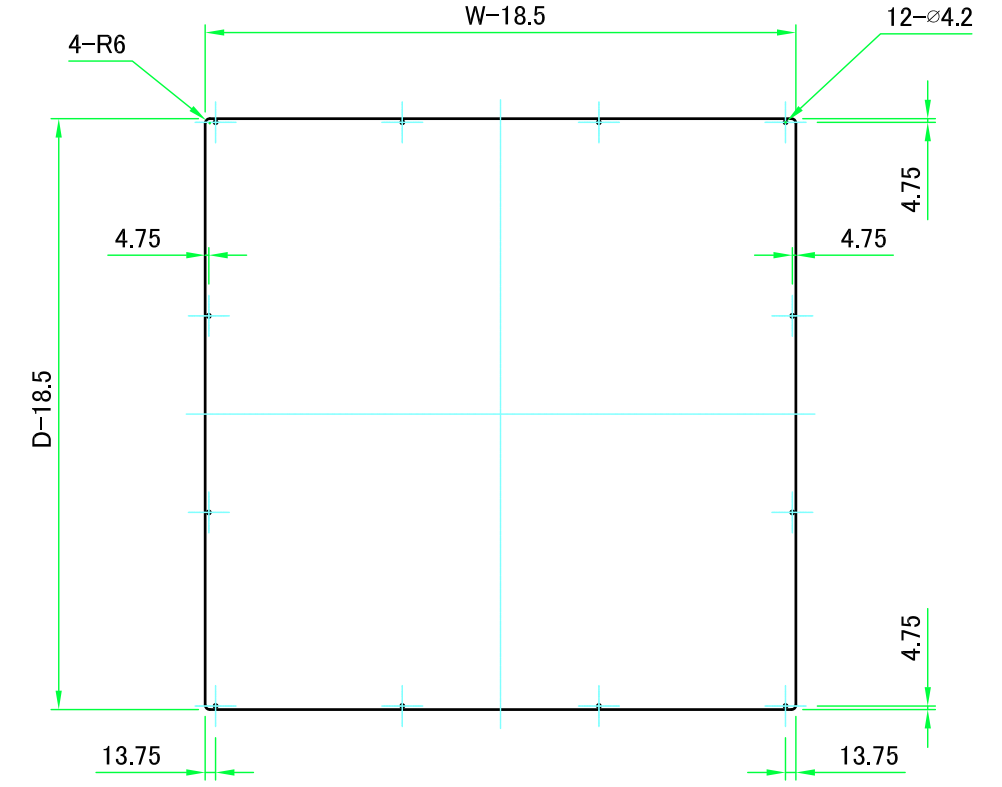

パネル裏面 / Panel Backside

株式会社タカチ電機工業 TAKACHI ELECTRONICS ENCLOSURE CO., LTD.			品名/Title パネル Panel	尺度/Scale 1:10
承認/Approved	検図/Checked	製図/Created	型番/Product number W591~1000 - D591~1000	
中根	野村	常山	作成日/Date 2019/09/03	7 / 7